



Faux Panels

Interior Installation Instructions

For Structural Walls Constructed Using Hardboard, Particleboard, Plywood, Rigid Foam Insulated Board & OSB



for Chevron, River Rock and Anson Fieldstone consult style-specific instructions.

General Tools and Materials:

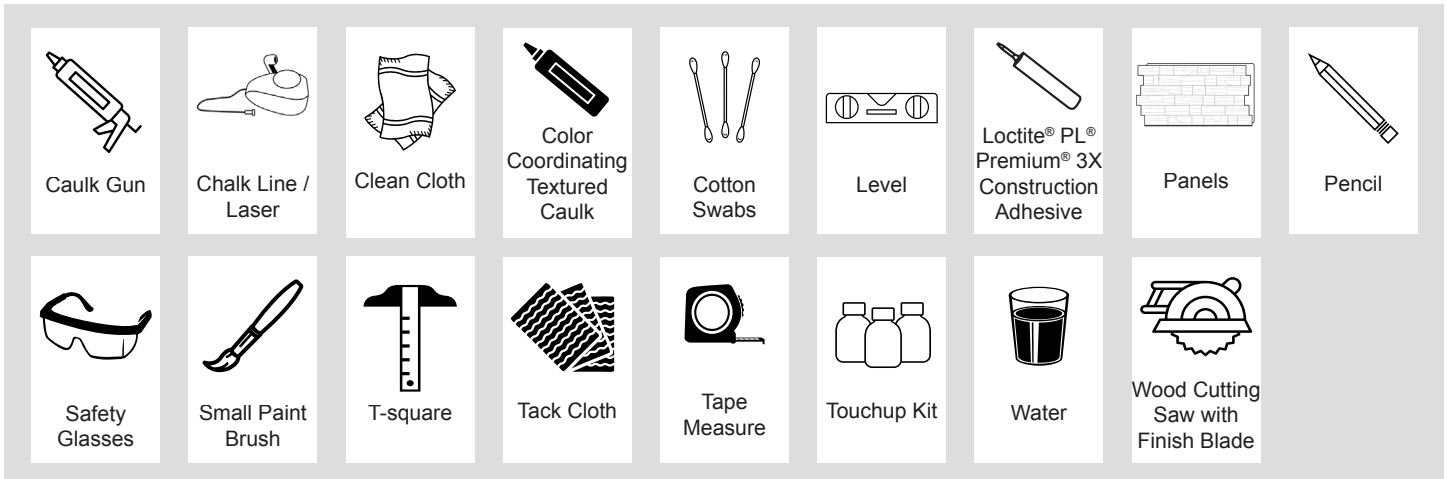

NOTE: (1) tube of Loctite PL Premium 3X adhesive is typically needed for every (3) panels.
(1) tube of textured caulk is typically needed for every (4) panels.

Installation-Specific Tools and Materials:

Adhesive & Fastener Installation

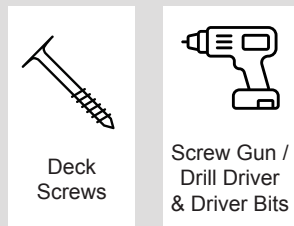

24 Hours Before Starting

Acclimate all panels by storing them flat in the installation location (but away from moisture and direct sunlight or other heat sources) for at least 24 hours.

Adhesive-Only Installation Over Concrete/Masonry/Metal



WARNING:

- Be sure to obey all safety rules and recommendations set forth by tool manufacturers.
- Wear safety glasses during the entire installation process.
- Be sure to follow all applicable building codes.
- Always comply with clearances set forth by the manufacturer of stoves, fireplaces, furnaces, and any other heat source.

Interior Installation

Before You Start

- Ensure wall is structurally sound and in good condition.
- Gather all tools and materials.
- If you will be working around corners, determine the best approach for your project using our installing faux panels around corners instruction sheet.

How to Determine Installation Workflow

WARNING: Your panels can only be installed one way. Before starting, look at your panels to determine which way they must be installed.

- Installation will run left to right or right to left depending on the panel style. Orient one of your panels so that the flat lip on the long side (A) is up. If the fingers project to the left, the installation will run left to right. If the fingers are on the right side of the panel, the installation will go right to left.

Left to Right Installation

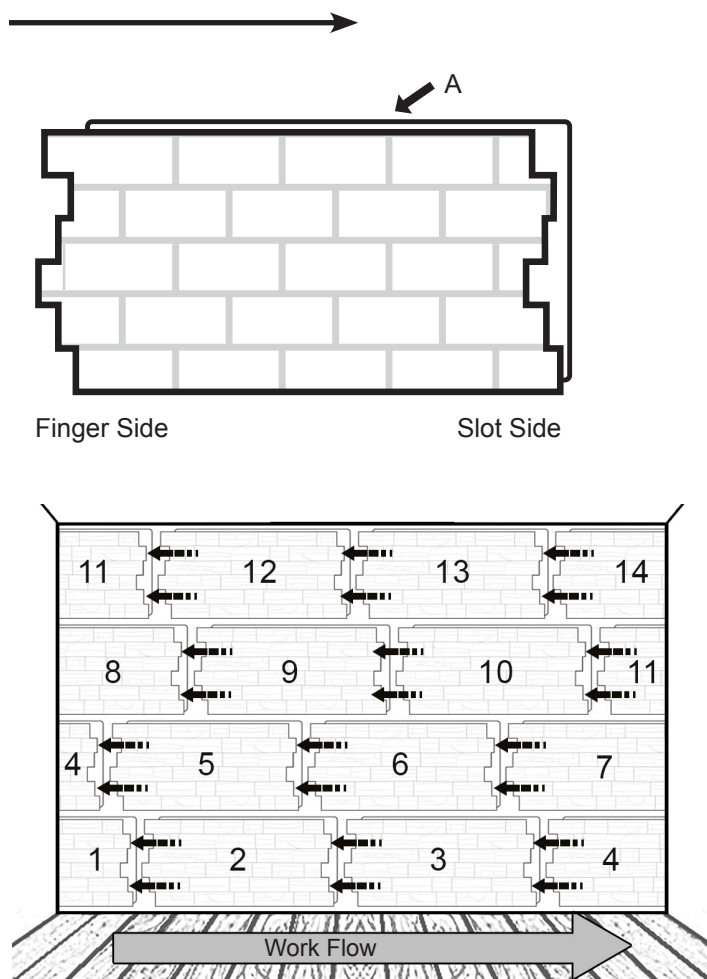

Right to Left Installation

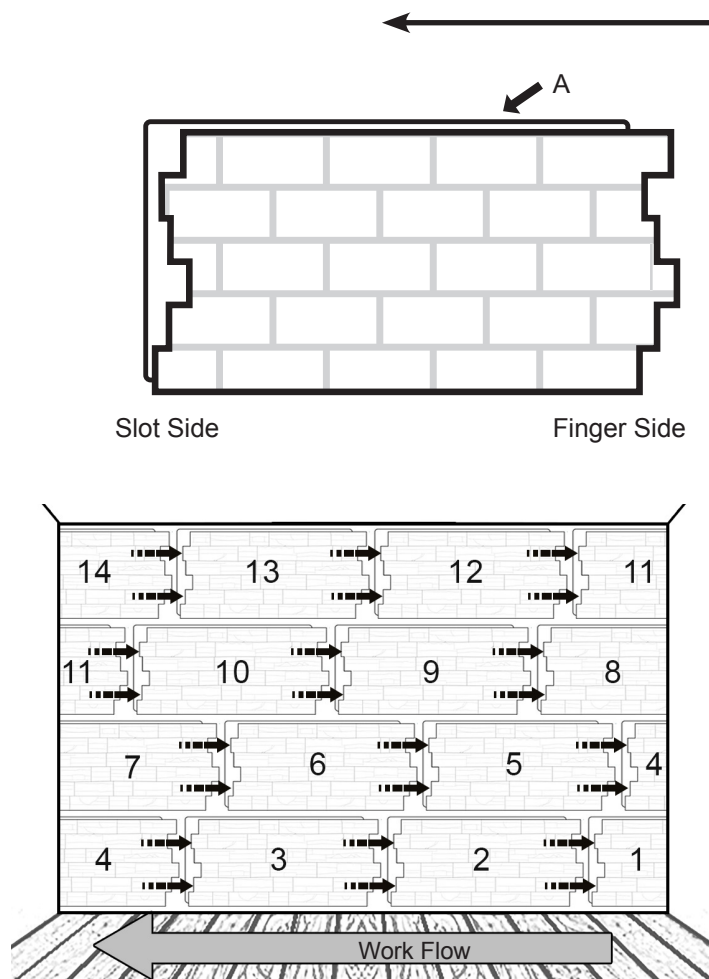

TIP: For styles other than Carolina, Carlton and Herringbone Brick, seams should be offset for a more realistic look. To reduce waste, try to use reserved portions from previously cut panels to start and finish each row. Panels may require shimming and trimming for proper alignment.

Interior Installation

1 Orient Panels & Determine Installation Order

1. Orient each of the panels so that the flat lip on the long side (A) is up.
2. Each panel is hand painted and unique. In some cases, a style includes multiple molds to create an even more realistic look. Frequently the panels will have "A" and "B" stamped on the flat lip (A) to indicate the different molds. When both are available, it is a good idea to try to alternate between A and B panels when installing.
3. It is often helpful to establish an order for the panels by laying them out prior to starting the installation process. Look at the variation in color and texture to ensure no one section draws the eye.

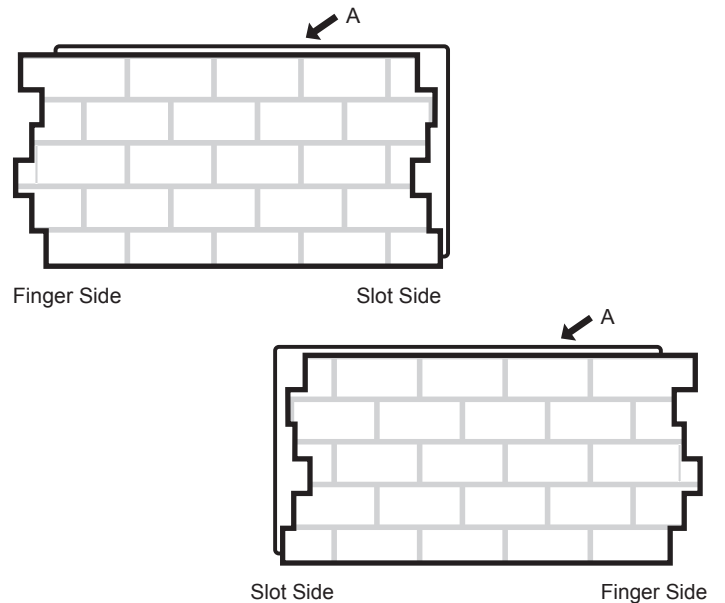

2 Prepare Surfaces

1. Ensure wall is stable and in good condition.
2. Wipe hard surfaces with a wire brush to remove loose debris.
3. Wipe walls with a tack cloth to remove any dirt or sawdust.
4. Clean surfaces are required to ensure the panels adhere properly.

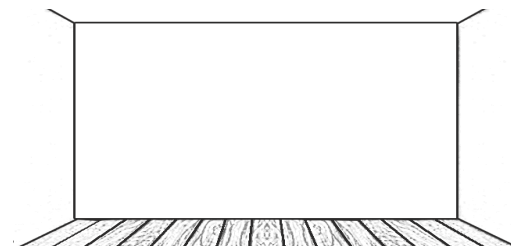

Clean Cloth



Tack Cloth



for Chevron, River Rock and Anson Fieldstone, consult style-specific instructions.

Interior Installation

3 Trim First Panel

NOTE: Skip if installing interlocking corners.

For all panels except Carolina, Carlton and Herringbone Brick:

1. Turn the panel over on a soft surface and mark where you intend to cut the panel. Trim the panel, using a wood cutting saw with a finish blade
2. We recommend cutting off at least $\frac{1}{4}$ of the panel to minimize waste.
3. The slot side will be used first. Reserve the finger side for use later in the project.

For Carolina, Carlton and Herringbone Brick panels:

NOTE: These styles will not have staggered seams.

1. Determine the number of panels needed to run the length of the first row.
2. Trim the bottom off each panel so that they will sit flush with the floor/ground.
3. Trim the fingers off the first panel.



Pencil



Tape Measure



T-square



Wood Cutting Saw with Finish Blade

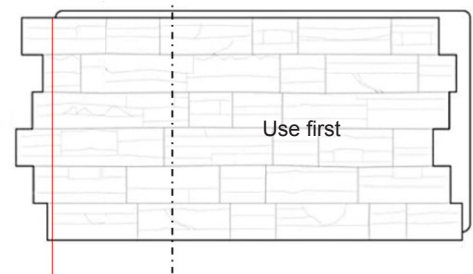

X Not recommended to trim only the fingers

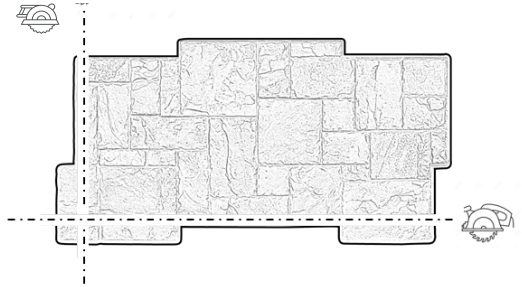

Vertical cut is for the first panel only.

Vertical cut is for the first panel only.

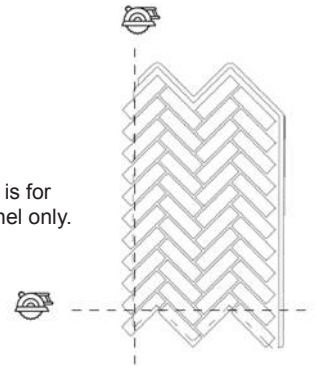

4 Draw Level Line

Find the high point on the floor/ ground using a level. Place a full size panel against the wall and mark the height. Draw a level line the length of the wall.



Pencil



Level / Laser Level



Chalk Line / Laser

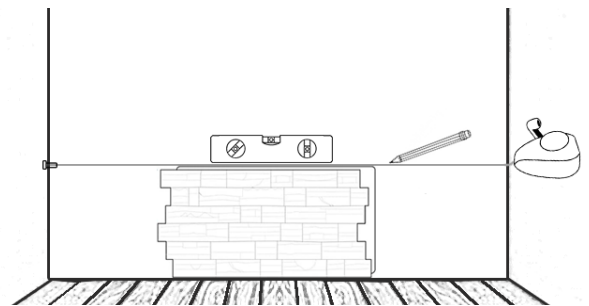

Interior Installation

5 Apply Adhesive

Wipe the back of the panel with a tack cloth to remove debris.

Adhesive and Fastener Installation:

Turn the panel over on a soft surface and apply beads of Loctite PL 3X adhesive to the back of the panel in vertical lines spaced no more than 3" apart. Also add a dab of adhesive to the back of each finger.

Adhesive-only Installation over Concrete/Masonry/Metal:

Wearing gloves and following the instructions on the Great Stuff Pro™ Construction Adhesive canister, turn the panel over and apply beads of Great Stuff Pro™ Construction Adhesive to the panel in vertical lines starting 2" from the edge and in 6" increments along the interior of the panel and a dab on the back of each panel finger. When applying to metal buildings ensure that the adhesive beads align with any embossed patterns in the cladding.

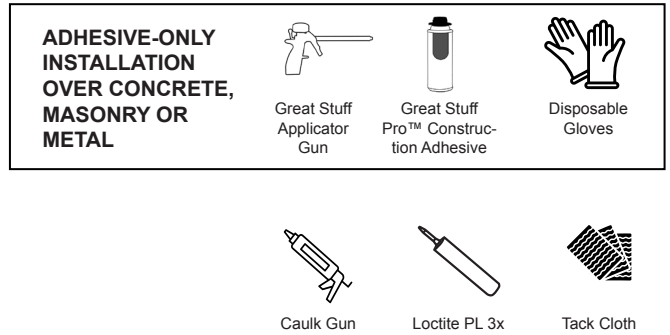
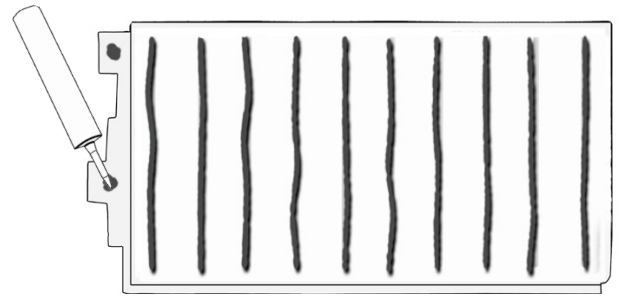

6 Adhere Panel to Wall

1. Use a slight twisting motion to ensure good contact.
2. Ensure panel is level, lines up with the level line drawn in *Step 4* and plumb with the edge of the wall.

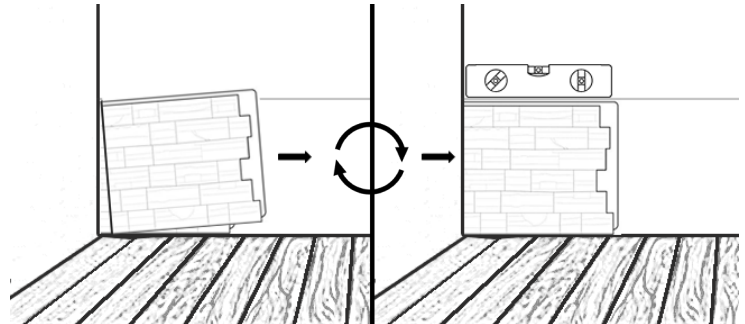
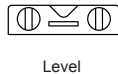

7 Screw Panel to Wall

NOTE: Skip this step if installing with adhesive only method.

Place (1) screw per foot along the perimeter and (1) screw per square foot in the middle of the panel. Screws should be slightly recessed. Place screws under protruding rocks or in grout lines to make them less noticeable.

Do NOT over tighten screws.

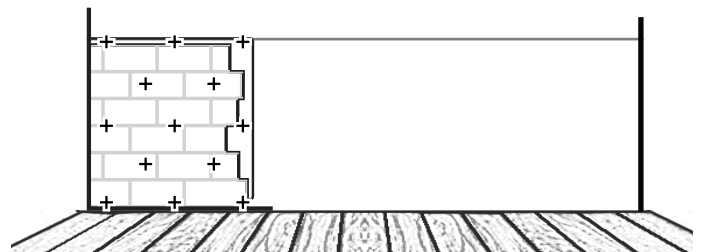

Deck Screws



Screw Gun / Drill Driver & Driver Bits

Interior Installation

8 Add Adhesive and Caulk

1. Add adhesive to the lip of the panel about 1" from the face.
2. Also apply a bead of textured caulk where the face meets the panel. *Caulk must be added during this step.* Adding caulk later will not protect against water and result in a less realistic appearance.
3. Use a damp cloth to remove any excess adhesive or caulk.

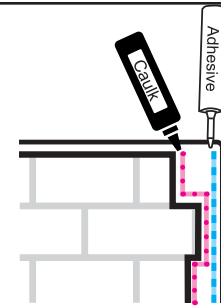

Clean Cloth



Caulk Gun



Color Coordinating Textured Caulk

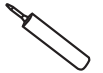

Loctite PL 3x

9 Repeat Steps 5-8

1. Butt the panels tightly together while following the level line. Dry fit each panel before applying adhesive to ensure it fits flush. Trim if necessary. The last panel on the row will have to be trimmed from the finger side of a panel.
2. Wipe off any excess caulk or adhesive with a damp cloth before it dries.

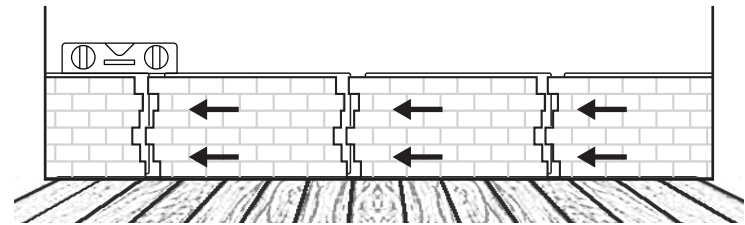

Clean Cloth



Caulk Gun



Color Coordinating Textured Caulk



Loctite PL 3x

TIP: Before cutting a full size panel, check to see if a previously cut panel can be used to finish the row.

10 Start Next Row

1. For multiple rows, start the next row directly above the first panel. Trim the first panel of the next row so that when installed the seams will be offset. You may be able to use a portion of a panel from another part of the job.
2. Carolina, Carlton and Herringbone Brick panels will not have offset seams. Trim only the left fingers off the starting panel.
3. Before installing each panel on the next row apply adhesive to the top lip of the panel below. Take care when placing the panel to ensure a tight fit with the panel below. Panels should come together to create a shiplap joint.

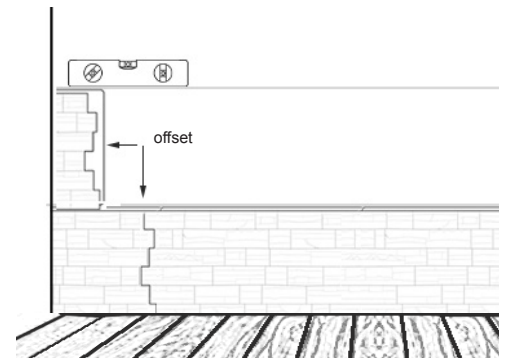
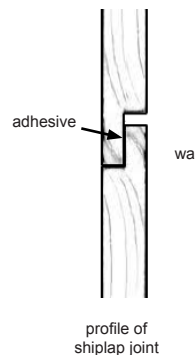

Chalk Line/ Laser



Wood Cutting Saw with Finish Blade



Loctite PL 3x



Pencil



Caulk Gun



Level

Interior Installation

11 Touch-Up As Needed

1. Add a bead of caulk to seal any mitered joints and where a panel butts against another surface (like an adjoining wall).
2. Add caulk to fill in voids, gaps and holes from screw heads. Carefully blend before it dries.
3. If your touch-up kit contains a base coat, use a cotton swab to apply a light layer of the base coat and allow it to dry completely (about 30 minutes).
4. Using a paint brush, apply the appropriate paint then dab with a soft cloth to blend and allow to dry completely (about 30 minutes).
5. If your touch-up kit contains a wash, apply the wash using a paint brush and dab with a soft cloth to blend. If the bottle is labeled “wash concentrate” add tap water to the neck of the bottle, screw the lid back on and shake to mix before using.

TIPS

- If you need to mix colors to achieve the desired shade, we recommend doing so on a piece of scrap material.
- Paint can be thinned by adding water.
- Start with lighter colors.

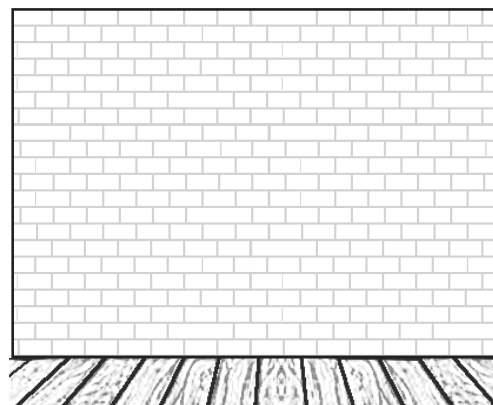

Water



Touch-up Kit



Paint Brush



Clean Cloth



Cotton Swabs



Caulk Gun



Color Coordinating
Textured Caulk